



**inspired design.  
expansive selection**

# Renaissance Series

## Brandywine



- All Wood Construction
- ¾" Solid Maple Face Frame
- Solid Maple Raised Panel Doors and Drawer Fronts with Applied Moldings
- ½" Plywood Box Construction with Wood Veneer Interiors and Exteriors
- ¾" Plywood Shelves
- Full Overlay Doors and Drawer Fronts
- Solid Wood Dovetail Drawer Box
- Soft Close Full Extension Drawer Glides
- Hand Rubbed Glaze
- 6 – Way Adjustable Concealed Hinges
- Soft Close Doors
- Wall Cabinets Available in the Following Sizes ; 30", 36" and 42"

## Sedona Chesnut



- All Wood Construction
- ¾" Solid Maple Face Frame
- Solid Maple Raised Panel Doors and Drawer Fronts with Applied Moldings
- ½" Plywood Box Construction with Wood Veneer Interiors and Exteriors
- ¾" Plywood Shelves
- Full Overlay Doors and Drawer Fronts
- Solid Wood Dovetail Drawer Box
- Soft Close Full Extension Drawer Glides
- Hand Rubbed Glaze
- 6 – Way Adjustable Concealed Hinges
- Soft Close Doors
- Wall Cabinets Available in the Following Sizes ; 30", 36" and 42"

## Tuscany



- All Wood Construction
- ¾" Solid Maple Face Frame
- Solid Maple Raised Panel Doors and Drawer Fronts with Applied Moldings
- ½" Plywood Box Construction with Wood Veneer Interiors and Exteriors
- ¾" Plywood Shelves
- Full Overlay Doors and Drawer Fronts
- Solid Wood Dovetail Drawer Box
- Soft Close Full Extension Drawer Glides
- Hand Rubbed Glaze
- 6 – Way Adjustable Concealed Hinges
- Soft Close Doors
- Wall Cabinets Available in the Following Sizes; 30", 36" and 42"

## Nantucket Linen



- High Density Fiberboard Raised Panel Doors and Drawer Fronts with Applied Moldings
- Full overlay design
- ¾" Solid Maple Face Frame
- ½" Plywood Box Construction with Wood Veneer Interiors and Exteriors
- ¾" Adjustable shelf
- 6-way adjustable hinges
- Solid Wood Dovetail Drawer Box
- Soft Close Drawer Glides
- Soft Close Doors
- Wall Cabinets Available in the Following Sizes; 30", 36" and 42"

## Stone Harbor Gray



- 3/4" Solid Wood Face Frame
- High Density Fiberboard Shaker Style Door and Drawer Front
- 1/2" Plywood Box Construction
- 5/8" Plywood Shelves
- Full Overlay Doors and Drawer Fronts
- Solid Wood Dovetail Drawer Box
- Soft Close Full Extension Drawer Glides
- Soft Close Doors
- 6 - Way Adjustable Concealed Hinges
- Wall Cabinets Available in the Following Sizes ; 30", 36" and 42"

## Arcadia Linen



- 3/4" Solid Wood Face Frame
- High Density Fiberboard Shaker Style Door and Drawer Front
- 1/2" Plywood Box Construction
- 5/8" Plywood Shelves
- Full Overlay Doors and Drawer Fronts
- Solid Wood Dovetail Drawer Box
- Soft Close Full Extension Drawer Glides
- Soft Close Doors
- 6 - Way Adjustable Concealed Hinges
- Wall Cabinets Available in the Following Sizes ; 30", 36" and 42"

## Arcadia White



- 3/4" Solid Wood Face Frame
- High Density Fiberboard Shaker Style Door and Drawer Front
- 1/2" Plywood Box Construction
- 5/8" Plywood Shelves
- Full Overlay Doors and Drawer Fronts
- Solid Wood Dovetail Drawer Box
- Soft Close Full Extension Drawer Glides
- Soft Close Doors
- 6 - Way Adjustable Concealed Hinges
- Wall Cabinets Available in the Following Sizes ; 30", 36" and 42"



# Choice Series

## Richmond Auburn



- All Wood Construction
- ¾" Solid Maple Face Frame
- Solid Maple Raised Panel Door and Drawer Fronts with Veneer Center Panels
- ½" Plywood Box Construction with Wood Veneer Interiors and Exteriors
- ⅝" Plywood Shelf
- Full Overlay Doors and Drawer Fronts
- Solid Wood Dovetail Drawer with Under Mount Glides
- 6 – Way Adjustable Concealed Hinges
- Available Upgrades
  - Soft Close Full Extension Drawer Glides
  - Soft Close Doors
- Wall Cabinets Available in the Following Sizes ; 30"and 36"

## Richmond Bordeaux



- All Wood Construction
- ¾" Solid Maple Face Frame
- Solid Maple Raised Panel Door and Drawer Fronts with Veneer Center Panels
- ½" Plywood Box Construction with Wood Veneer Interiors and Exteriors
- ⅝" Plywood Shelf
- Full Overlay Doors and Drawer Fronts
- Solid Wood Dovetail Drawer with Under Mount Glides
- Detailed Glazing
- 6 – Way Adjustable Concealed Hinges
- Available Upgrades
  - Soft Close Full Extension Drawer Glides
  - Soft Close Doors
- Wall Cabinets Available in the Following Sizes ; 30"and 36"



## Regal Oak

---



- All Wood Construction
- 3/4" Plywood with Veneer Oak Face Frame
- Solid Oak Raised Panel Door with Veneer Center Panel
- 1/2" Plywood Box Construction
- 5/8" Plywood Shelf
- Side Mount Glides and Plywood Drawer Box
- Concealed Hinges
- Wall Cabinets Available in the Following Sizes; 30", 36" and 42"



## Lancaster Shaker

---



- All Wood Construction
- 3/4" Plywood with Veneer Oak Face Frame
- Shaker Style Door and Drawer Front with Veneer Oak
- 1/2" Plywood Box Construction
- 5/8" Plywood Shelf
- Side Mount Glides and Plywood Drawer Box
- Concealed Hinges
- Wall Cabinets Available in the Following Sizes; 30"



## Charleston Traditional Cognac

---



- All Wood Construction
- 3/4" Plywood with Veneer Maple Face Frame
- Raised Panel Plywood Door and Drawer Front with Veneer Maple
- 1/2" Plywood Box Construction
- 5/8" Plywood Shelf
- Side Mount Glides and Plywood Drawer Box
- Concealed Hinges
- Wall Cabinets Available in the Following Sizes; 30"



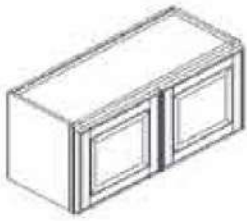

W3012-W3612  
W2415-W3615  
W2418-W3618  
W2424-W3624(1 shelf)

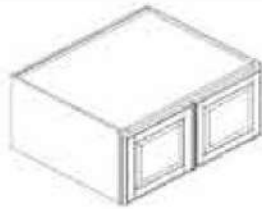

W301224-W361224  
W331524-W361524  
W361824  
W332424-W362424(1 shelf)



W0930-W2130(2 shelves)  
W0936-W2136(2 shelves)  
W0942-W2142(3 shelves)

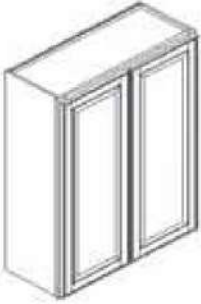

W2430-W4230(2 shelves)  
W2436-W3636(2 shelves)  
W2442-W4242(3 shelves)  
W6030 Refer to website for details

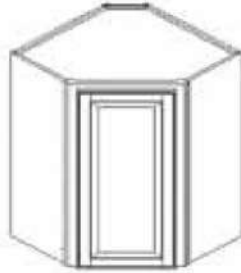

WDC2430(2 shelves)  
WDC2436(2 shelves)  
WDC2442(3 shelves)  
WDC2736(2 shelves)  
WDC2742(3 shelves)

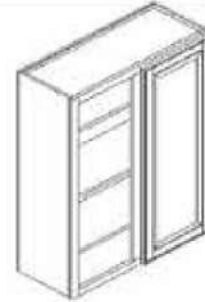

WBC2730(2 shelves)

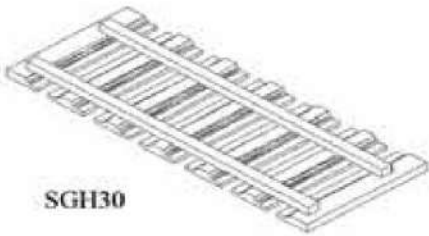

SGH30

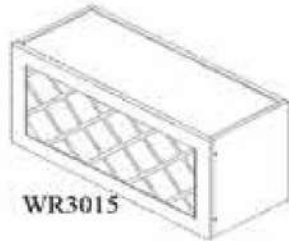

WR3015

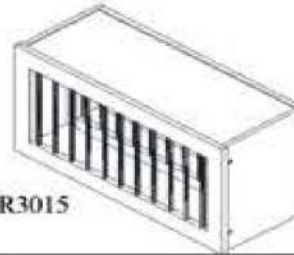

PR3015

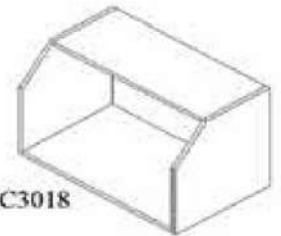

MC3018

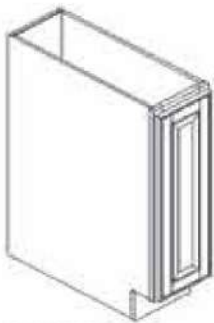

BFH09

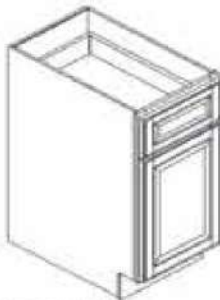

B12-B21

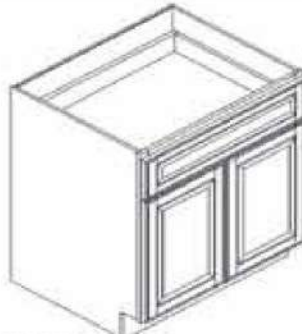

B24-B30

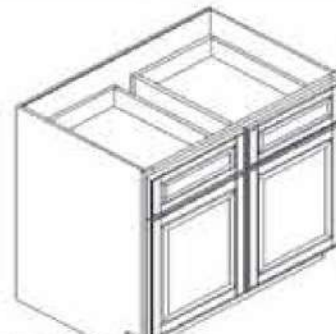

B33-B42

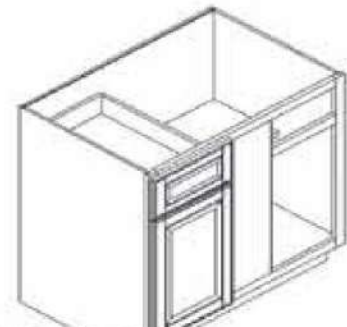

BBC42-45

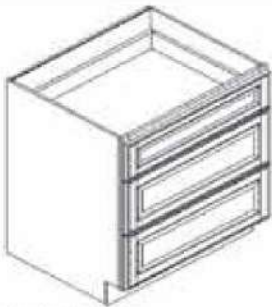

DB15-DB30

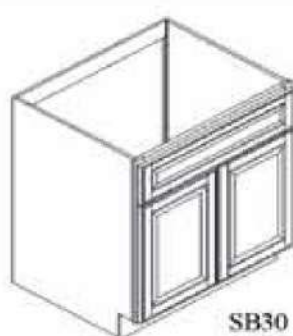

SB30

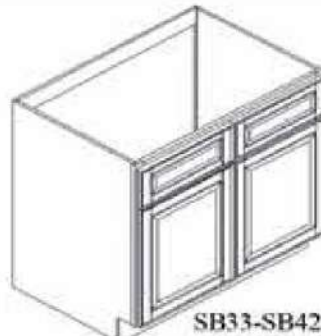

SB33-SB42

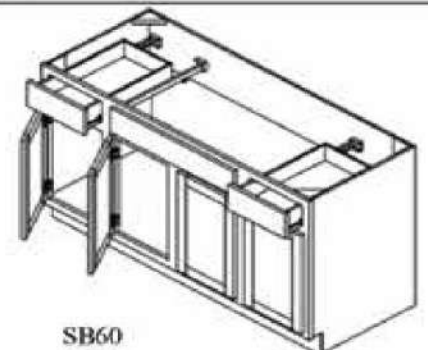

SB60

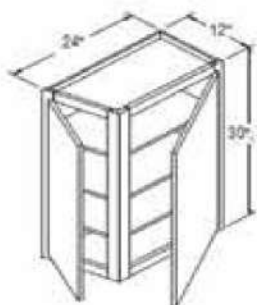

WAC30  
WAC36  
WAC42

30°, 36°, or 42°

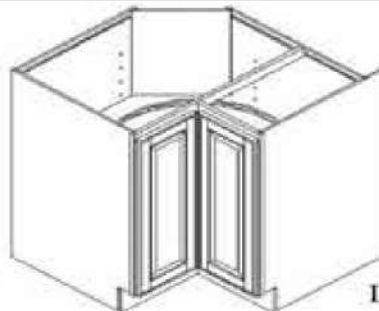

DCB3612

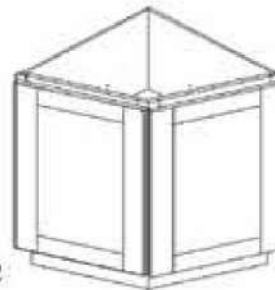

BC24

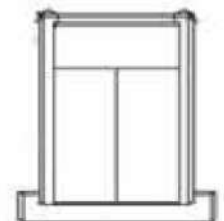

CSF36

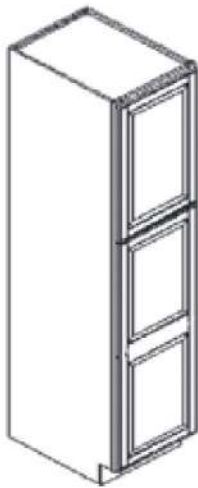

WP1884  
WP1890  
WP1896



WP2484  
WP2490  
WP2496

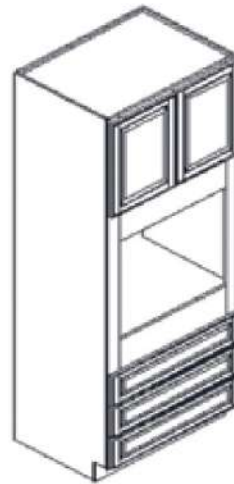

OU332484  
OU332490



BEP3L-3" Face stile  
RP84-1.5" Face stile  
RP90-1.5" Face stile  
RP96-1.5" Face stile



BF3

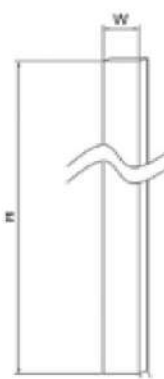

FS330  
FS336  
FS342  
FS642  
FS636  
FS384  
FS396

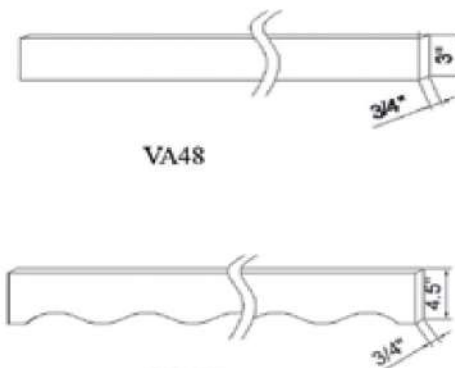

VA48

VAS48

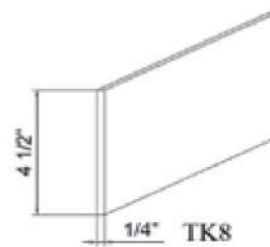

1/4" TK8

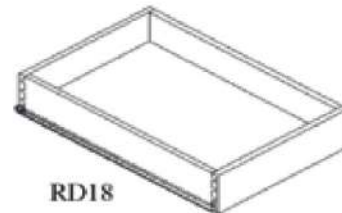

RD18  
RD24

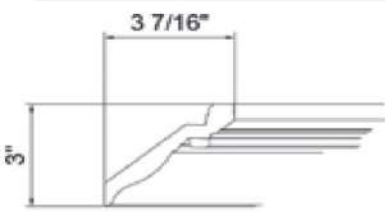

CM8+DM8

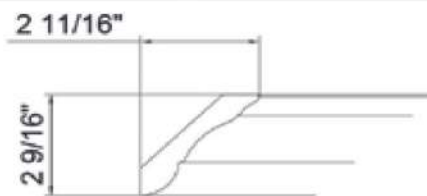

CM8

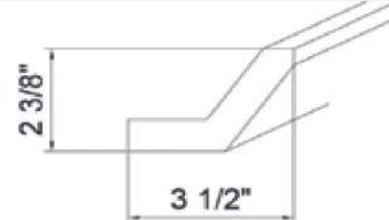

SM8

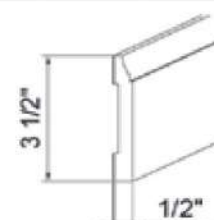

FBM8

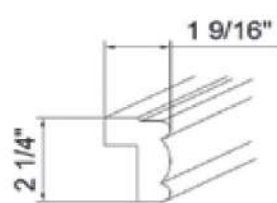

LRM7

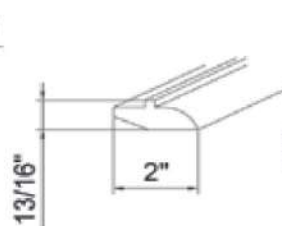

LRMS7

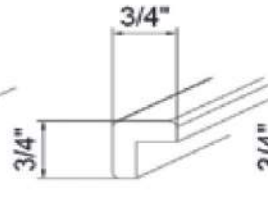

OSC7

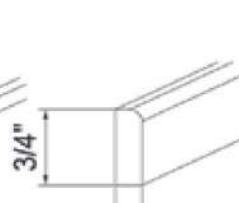

SCM7



CSF Floor(1/2" plywood)

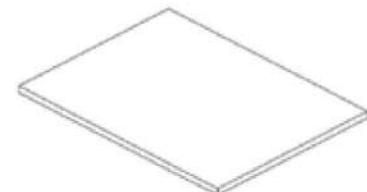

Oak Pantry Shelves

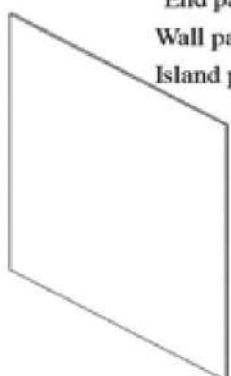

End panel 24 x 35 x 3/16  
Wall panel 12 x 42 x 3/16  
Island panel 3' x 4' x 1/4"



Mullion door  
1530,36,42MD  
1830,36,42MD  
3030,36,42MD  
3630,36,42MD  
DC2430,36,42MD  
DC2736MD  
DC2742MD

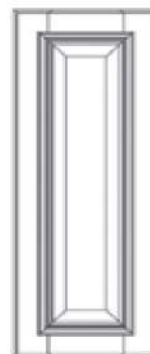

Deco Doors  
30DD  
36DD  
42DD  
BDD



SRI-NM



[contractordirectwindows.com](http://contractordirectwindows.com)